

Citadel™

Deep Well Plates & Cluster Tubes



Secure Vessels for Storage & Reaction

SSIbio 

Deep-Well Plates

Ideal for sample collection, preparation, and long-term storage.

- HTS-friendly—compatible with most liquid-handling robots.
- Centrifugation to 4,000 x G RCF.
- Manufactured from virgin polypropylene to ensure purity and sample integrity, chemical resistance, and compatibility with long-term storage needs.
- Alphanumeric indexing molded in on A-H and 1-12 axes.
- Optimum sample mixing and recovery with highly-polished wells and radiused corners.
- Raised rims on each well facilitate secure sealing with films and sealing mats.
- Bar coded plates available—contact SSIBio for details.
- Autoclavable.
- Certified free of detectable DNase, RNase, DNA, and PCR inhibitors. Sterile plates are also pyrogen-free.



7631-00



775B-00



7651-00



7753-00



7832-00

Deep Well Plates

Item #	Description	Number of Wells	Packaging
7631-00	1.1 mL Deep-Well Plate, Round Bottom	96 Round Wells	5/unit, 10 units/case
7631-S0	1.1 mL Deep-Well Plate, Round Bottom, Sterile		
775B-00	1.1 mL Deep-Well Plate, Square, V-Bottom	96 Square Wells	
7651-00	2 mL Deep-Well Plate, Round Bottom	96 Round Wells	
7651-S0	2 mL Deep-Well Plate, Round Bottom, Sterile		
7753-00	2 mL Deep-Well Plate, Square, V-Bottom	96 Square Wells	
7753-S0	2 mL Deep-Well Plate, Square, V-Bottom, Sterile		
7832-00	240 µL Deep-Well Plate, V-Bottom	384 Square Wells	
7832-S0	240 µL Deep-Well Plate, V-Bottom, Sterile		

Sealing Foils and Mats

- Sealing foil is DMSO-resistant and specially designed for deep well plates.
- Silicone sealing mats are reusable and pierceable.
- Temperature range for foil or mats: -80° to + 120°C.

Item #	Description	Well Fit	Packaging
76M1-00	Sealing Mat for Deep-Well Plate	96 Round Wells	10/unit, 5 units/case
76M1-S0	Sealing Mat for Deep-Well Plate, Sterile		
77M1-00	Sealing Mat for Deep-Well Plate	96 Square Wells	
77M1-S0	Sealing Mat for Deep-Well Plate, Sterile		



76M1-00



77M1-00

Reservoir

Item #	Description	Volume	Max Volume	Number of Channels	Packaging
7A5A-00	12-Channel Reservoir	20 mL	22 mL	12 Channels	5/unit, 4 units/case



7A5A-00

Citadel™

Secure Vessels for Storage & Reaction

Citadel Deep-Well Plates and Cluster Tube Systems are ideal for high-throughput screening processes and long-term storage. It all begins with medical-grade, virgin polypropylene, combined with proprietary injection molding techniques to produce high-clarity vessels that are exceptionally robust, chemically-resistant, and pure.

- Deep-well plates are ideal for sample collection, prep, and long-term storage.
- Cluster tubes are ideal for storage, dilution, mixing, harvesting, culture assays, and screening.
- Deep-well plates and tube racks have SBS footprint for use in automation.

Cluster Tubes & Rack Systems

Rack system is suitable as a reaction vessel in your robotic workstation or as a long-term storage vessel in your sample library.



A clear lid is a standard part of the rack system.

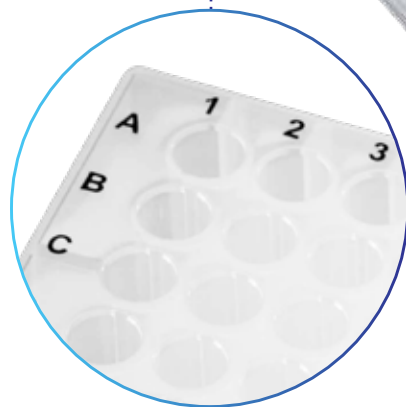

Bold, black alphanumeric indexing

Available with individual tubes, strips of 8 tubes, or strips of 12 tubes.



Tubes and racks are made from virgin polypropylene; strip caps are polyethylene.

Cluster Tubes & Rack Systems

Ideal for storage, dilution, mixing, harvesting, culture assays, and screening.

- SBS footprint; 8 × 12 format.
- Ideal for automation / HTS.
- Available in individual tubes, strips of 8 tubes, and strips of 12 tubes.
- Tubes and racks are made from virgin polypropylene; strip caps are polyethylene.
- Rack systems are suitable as a reaction vessel in your robotic workstation or as a long-term storage vessel in your sample library.
- A clear lid is a standard part of rack system.
- Bold, black alphanumeric indexing.
- Autoclavable.
- Certified free of detectable DNase, RNase, DNA, and PCR inhibitors. Sterile tubes and plates are also pyrogen-free.



703A-00



703B-00



703C-00

Non-Racked Tubes

Item #	Sterile Item #	Volume	Description	Packaging
703A-00	n/a		Individual Tubes	1000/unit, 10 units/case
703B-00	n/a	1.2 mL	Strips of 8 Tubes	125/unit, 10 units/case
703C-00	n/a		Strips of 12 Tubes	80/unit, 10 units/case

Cap Strips

Item #	Sterile Item #	Description	Packaging
7032-00	7032-S0	Strips of 8 Caps	125/unit, 10 units/case
7033-00	7033-S0	Strips of 12 Caps	80/unit, 10 units/case

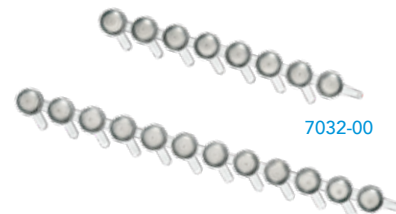

7032-00

7033-00

Racked Tubes with Lid

- Rack system is suitable as a reaction vessel in your robotic workstation or as a long-term storage vessel in your sample library.

Item #	Sterile Item #	Tube Volume	Description	Packaging
713A-00	713A-S0		Individual Tubes, Racked	10/unit, 10 units/case
713B-00	713B-S0	1.2 mL	Strips of 8 Tubes, Racked	10/unit, 10 units/case
713C-00	713C-S0		Strips of 12 Tubes, Racked	10/unit, 10 units/case



713A-00

713B-00

713C-00

Citadel™ Deep Well Plates

SBS footprint meets ANSI/SLAS 1-2004.



Stackable.

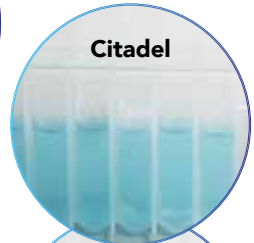

Citadel



A Leading Brand

Ultra-clear for easy visualization of samples.

Flatness tested for reliable automation performance.

Purity Assured

Products are certified free of RNase DNase, DNA, and PCR inhibitors, also endotoxin-free.

High-Contrast Alphanumeric Indexing molded in on A-H and 1-12 axes.

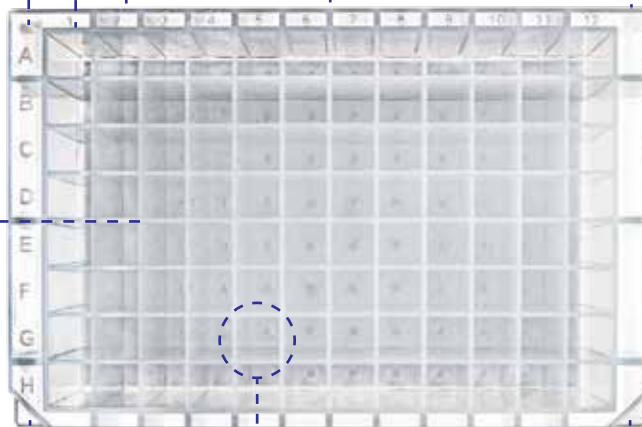

7753-00



Autoclavable

Products may be sterilized at 121°C and 15psi for 15 minutes.



Raised rims on each well facilitate secure sealing with films or sealing mats.



Recyclable

All tubes and plates are manufactured from virgin polypropylene and fully compliant with recycling standards.

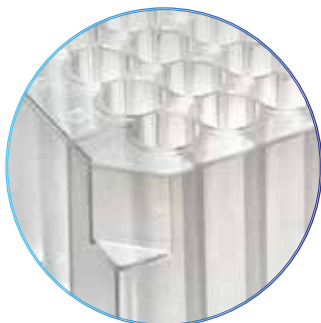

Corner notches at H1 and H12 for easy orientation.

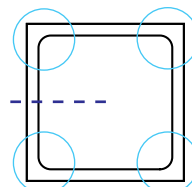

Radiused corners.

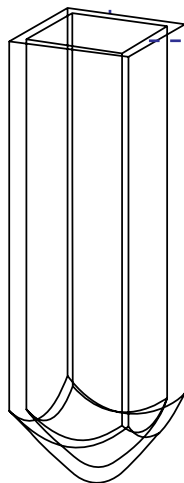

Radiused corners and highly-polished wells with smooth transitions prevent capillary wicking and facilitate thorough sample mixing and recovery.

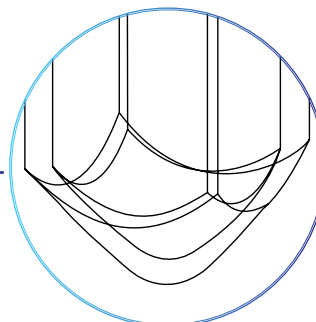

Smooth transitions.

Citadel™

Deep Well Plates & Cluster Tubes

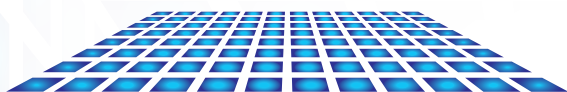

Innovations for Life Science

For more than 25 years, Scientific Specialties, Inc. has focused on bringing innovative, high-quality plasticware to life science. From the initial concept of a product to its finished form, all aspects of the design, production, and final inspection are controlled by processes that are ISO-certified.

Citadel vessels are produced in a fully-automated, climate-controlled clean environment unparalleled in our industry. This ensures that product is uniform, pure, and worthy of your trust—every time.



Secure Vessels for Storage & Reaction



Scientific Specialties, Inc.
1310 Thurman Street, Lodi, CA USA 95240
Phone: + 1 (209) 333-2120
www.SSIbio.com



Made in USA